

MAJORITY

BEN NEVIS II

Bluetooth Soundbar with Subwoofer

BEN-BAR-BLK-2



Instructions Guide

Contents

Controls And Functions	1
What's In The Box?	5
Support	6
Instructions Guide	7
Fixing the Soundbar: Using the RCA Audio Cable	7
Fixing your Soundbar: Using the Optical Input	8
Using the MP3 LINK Connection (Line In)	9
Connecting to the Mains Supply	10
Connecting the Soundbar and Sub-woofer	11
Bluetooth Operation.....	12
FM Mode	14
Troubleshooting	15
Specification	16
Warranty	16
Safety Information	17

3 YEAR
WARRANTY

Watch video tutorials and register
your product for a FREE 3-year warranty
at www.majorityradios.co.uk

Side View/Control Buttons

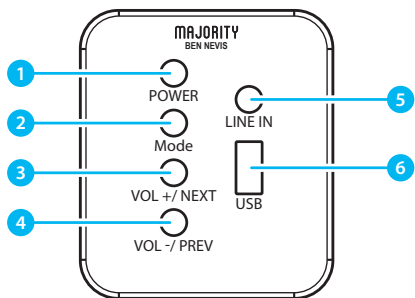

1. Power
2. Mode
3. Volume +/Next
4. Volume-/previous
5. Line In
6. USB Function

Back View

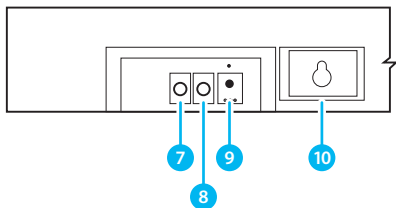

7. Subwoofer Output
8. Optical Input
9. DC Power Input
10. Wall Bracket

Controls And Functions

Remote Control

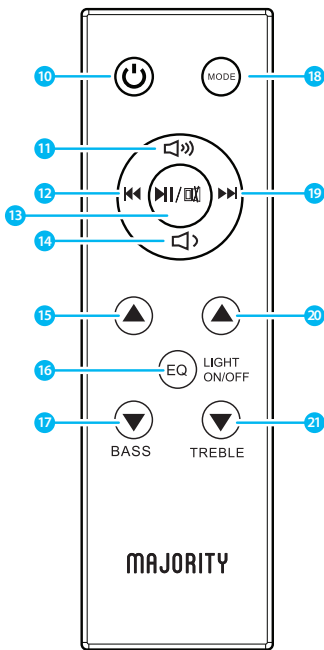

- 10. Power On/Off**
Switch the unit between on and Standby mode
- 11. Volume +**
Press to increase the volume
- 12. Back Step**
Use in AUX or Bluetooth mode to go back a track.
- 13. Play/Pause**
Press to play and pause
- 14. Volume -**
Press to decrease the volume
- 15. Bass increase**
Press to increase the bass
- 16. EQ**
Press the button to adjust the equaliser. Press and **hold** the button to turn the soundbar LED light on and off.
- 17. Bass decrease**
Press to decrease the bass
- 18. MODE**
Press button repeatedly to switch between soundbar modes
- 19. Forward Step**
Use in AUX or Bluetooth mode to go forward a track
- 20. Treble increase**
Press to increase the treble
- 21. Treble decrease**
Press to decrease the treble

Using the Remote Control

The remote control sensor at the front of the soundbar is sensitive to the remote control's commands up to a maximum of 8 metres away and within a maximum arc of 30 degrees.

Please note that the operating distance may vary depending on the brightness of the room.

Subwoofer

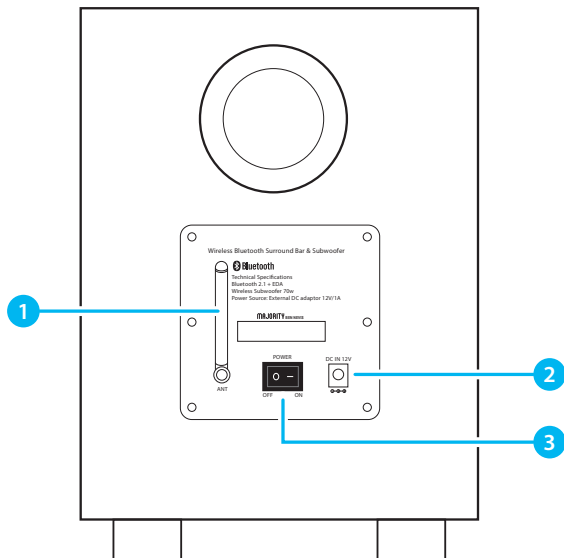

1. Bluetooth Receiver
2. DC adapter input
3. Power Switch

Box Contents

1. Majority Ben Nevis Soundbar
2. Remote Control
3. Power Adapter x 2
4. 3.5mm to 3.5mm Audio Cable
5. Bluetooth Subwoofer
6. Instruction Manual

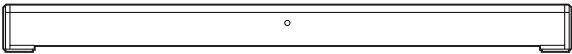

1. Majority Ben Nevis II Soundbar

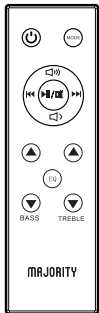

2. Remote Control

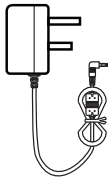

3. Adapter



4. Audio Cable

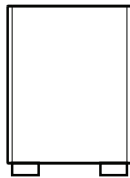

5. Subwoofer

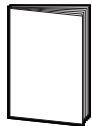

6. Instruction Guide

Support

Thank you for your purchase of the Majority Ben Nevis II.

Please follow the guidance of the manual to set up your new purchase and begin enjoying its features.

If you require further assistance with your new soundbar, please contact our support team on the Majority website:

<https://www.majorityradios.co.uk/support>

Fixing the Soundbar: Using the RCA Audio Cable

Use the RCA Stereo Audio Cable to connect the TV's stereo RCA(L/R) audio output socket.

Connect the audio output cable to the side of the Sound bar via the 'LINE IN' input sockets of the unit (**Ref.5**)

Then press the **MODE** on the remote control (**Ref.18**) or press the **Mode** button on the unit (**Ref.2**) to scroll to the **LINE** function.

Turn on your television set to use the Majority Ben Nevis.

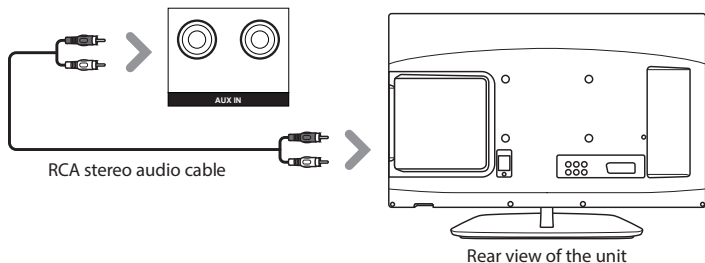

Fixing your Soundbar: Using the Optical Input

You will need: An audio source with an Optical Audio Output and a Digital Optical Audio cable (not included)

Connect the Digital Optical Audio cable to the optical output on the audio source and to the Optical Input on the speaker bar (**Ref.8**)

Press the POWER button on the soundbar (**Ref.1**) or POWER button directly on the remote control (**Ref.10**) to switch on the unit.

Press the MODE button on the remote control (**Ref.18**) to switch to Optical mode or select the Mode button (**Ref.2**) on main unit repeatedly to select the Optical mode.

Using the native controls on your connected device, make sure the audio settings are set to PCM or Optical Audio and are turned On. Audio from the connected audio source will now be played through the speakers.

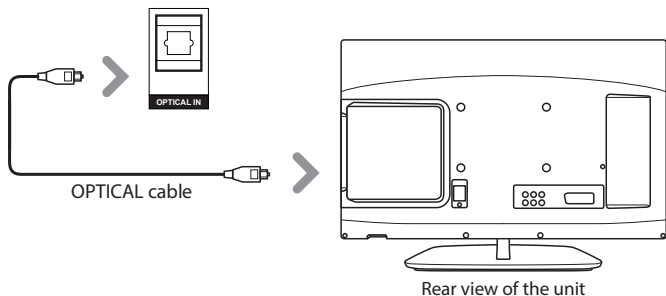

Using the MP3 LINK Connection (Line In)

Plug one end of a 3.5mm audio input cable (included) into the Line In on the unit (**Ref.5**). Before use, disconnect any cables connected to the Stereo RCA Inputs.

Plug the other end of the cable into the audio output/headphone output on an MP3 player or other audio source.

Press the Power button on the soundbar (**Ref.2**) or POWER button directly on the remote control (**Ref.10**) to switch on the unit.

Press the Mode button repeatedly on the soundbar (**Ref.2**) or press the MODE button on remote control (**Ref.18**) repeatedly to enter LINE in mode.

Audio played through the connected device will now be heard through the speakers.

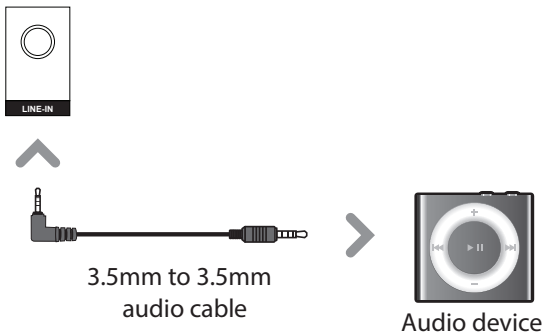

Connecting to the Mains Supply

Ensure that the power supply voltage is in the voltage of 100V~240V.

This unit is designed to use adapter.

Connecting the unit to any other power source may cause damage to the unit.

Unwind the mains cable to its full length. Connect the mains plug to a mains socket. Make sure the mains plug is fully inserted into the mains socket.

Connect the Adapter to the unit and AC Socket (**Ref.9**)

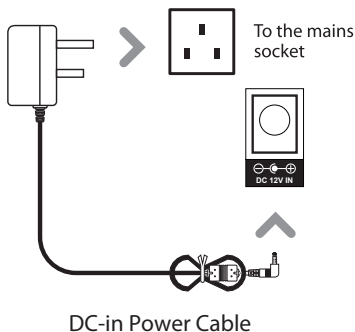

Ensure all audio connections of the unit are connected before connecting to the mains power socket.

Unplug the power cord from the outlet when the unit is use for an extended period of time.

Connecting the Soundbar and Sub-woofer

The sub-woofer and soundbar will wirelessly connect to each other for a surround sound experience. This allows you to place the sub-woofer within the corner of the room to ensure that the sound from your TV fills the room.

To connect them together, please ensure that your soundbar is being mains powered and switched 'ON' for initial set up. To do this, press the Power button (**Ref.1**) on the unit or the POWER button on the remote control (**Ref.10**)

Follow by plugging the sub-woofer into a power source, and turning it ON via the power switch (**Sub Woofer Ref.3**)

The sub-woofer and soundbar should then automatically connect via wireless Bluetooth connectivity.

If you are having connectivity issues, please move the sub-woofer closer to the soundbar for set up.

Bluetooth Operation

Pairing a Bluetooth Device for the First Time

Press the POWER button on the unit (**Ref.1**) or the POWER button on the remote control (**Ref.10**) to switch on the unit.

Select and press the MODE button repeatedly on the remote control until in Bluetooth mode (**Ref.18**) or press the Mode button (**Ref.2**) repeatedly on the soundbar to enter Bluetooth mode.

Using the native controls on your Bluetooth device, select the "Majority Ben Nevis II" in your Bluetooth settings to pair.

If your device requests a password, enter the default "0000". Refer to the user manual for your specific device for instructions on pairing and connecting Bluetooth devices.

When successfully paired and connected, a beep will issue from the unit. After initial pairing, the unit will stay paired unless unpaired manually by the user.

If your device should become unpaired or you find it is unable to connect, repeat the above steps.

Playing Audio Wirelessly

Follow the instructions for pairing a Bluetooth device.

Use the native controls on the connected Bluetooth Device to select a track.

To Play/Pause the track or Skip Forwards/Backwards to a selected track, use the remote control (**Ref.12, 13, 19**)

Audio played through the connected Bluetooth device will now be heard through the speakers.

FM Mode

Select and press the MODE button repeatedly on the remote control (**Ref.18**) or press the Mode button on the soundbar repeatedly to enter FM mode (**Ref.2**).

Ensure that the wire aerial on the back panel of the sound bar is extended.

When on FM mode, press and **hold** the 'Play/Pause' button on the remote (**Ref.13**) or on the soundbar to begin searching for available FM stations.

After the search is complete, the soundbar will save the stations with good signal. To scroll through these saved stations, press the 'Previous/Next' buttons on the remote control (**Ref.12/19**).

Please note:

If you are having trouble with receiving stations, complete another auto-scan and adjust the aerial if needs be.

Troubleshooting

If the Soundbar does not work properly as desired, please check the following checklist.

Malfunction	Possible causes/measures
No power / function	Check whether the power is switched on or off at the wall. Check whether the power adaptor is properly connected to power outlet or not.
No sound	Check whether cables are properly installed. If they are, please try alternative cable to connect to your TV if possible. Check unit is out of standby and in mode.
No sound from bluetooth connection	Forget the soundbar from your device and reconnect. Check whether external device requires password "0000" to start with.
Function disturbance	Switch off and unplug the unit. Leave it for 2 minutes and switch it on again. If a particular mode is causing problems, please try an alternative connection to your TV such as Optical or Bluetooth.
Remote control does not work [properly]	Check whether the battery run out or not. Replace with a new one if necessary. Check whether there is obstacle on the front of remote sensor.

Specifications

Specification

Power Supply	DC 12V/1A
Power Consumption	75W
Power Output (max)	75W*2 + 75W Subwoofer
Frequency Response	+/- 3dB
Bluetooth	V3.0
Dimension (WxHxD)	76.2 x 5.3 x 6.9 cm sound bar 28 x 19.7 x 19.7 cm sub woofer

Warranty

All products come with a standard 12 month warranty. All items must be registered on www.majorityradios.co.uk for the warranty to be valid. Once on the web page, use the menu to find "Register Your Product". You will also be given the chance to extend your warranty for an additional 24 months, free of charge.

1. **Read these instructions.**
2. Keep these instructions. Instructions are also available for download at www.majorityradios.co.uk
3. Heed all Warnings
4. Follow all instructions
5. Do not clean the apparatus near or with water
6. Do not block any ventilation openings. Install in accordance with the manufacturer's instructions
7. Do not install near any heat sources such as radiators, heat registers, stoves, or other apparatus (including amplifiers) that produce heat.
8. Protect the power from being walked on or pinched particularly at plugs, convenience receptacles, and the point where they exit from the apparatus.
9. Only use attachments/accessories specified by the manufacturer.
10. Unplug this apparatus during light storms or when unused for long periods of time.
11. Refer all servicing to qualified service personnel.
Servicing is required when the apparatus has been damaged in a way, such as power-supply cord or plug is damaged, liquid has been spilled or objects have fallen into the apparatus, the apparatus has been exposed to the rain or moisture, does not operate normally or has been dropped.
12. No naked flame sources, such as lit candles, should be placed on the apparatus.
13. Dispose of used electrical products and batteries safely according to your local authority and regulations.

ADDITIONAL WARNINGS

The apparatus shall not be exposed to dripping or splashing and no objects filled with liquid, such as vases, shall be placed on the apparatus.
Main plug is used to disconnect device and it should remain readily operable during intended use. In order to disconnect the apparatus from the main mains completely, the mains plug should be disconnected from the main socket outlet completely.
Battery shall not be exposed to excessive heat such as sunshine, fire or the like.

RECYCLING ELECTRICAL PRODUCTS

You should now recycle your waste electrical goods and in doing so help the environment.



This symbol means an electrical product should not be disposed of with normal household waste. Please ensure it is taken to a suitable facility for disposal when finished with.

IMPORTANT: Please read all instructions carefully before use and keep for future reference.



Risk of electric shock.
Do not open



Read all instructions carefully before use and keep for future reference



When servicing, use only identical replacement parts



CAUTION

RISK OF ELECTRIC SHOCK
DO NOT OPEN



ATTENTION

RISQUE D'ELECTROCUTION
NE PAS OUVRIR



IMPORTANT: Please read all instructions carefully before use and keep for future reference

MAJORITY

www.majorityradios.co.uk